

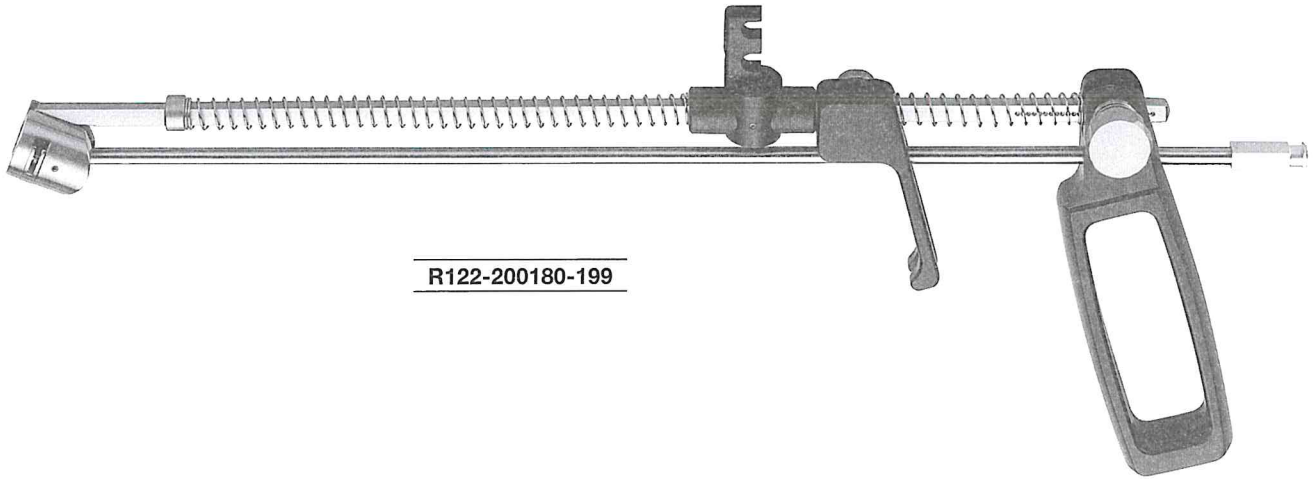





Uterus Manipulator
complete with 6 different cones



R122-200180-199

	working length	Ø	
	45 mm	3 mm	Uterus obturator, thin, short <u>R122-030045-000</u>
	55 mm	3 mm	Uterus obturator, thin, long <u>R122-030055-000</u>
	80 mm	8 mm	Uterus obturator, medium, long <u>R122-080080-000</u>
	100 mm	10 mm	Uterus obturator, thick, extra long <u>R122-100100-000</u>
	60 mm	25 mm	Cone, with short thorn <u>R122-250060-000</u>
	70 mm	25 mm	Cone, with long thorn <u>R122-250070-000</u>
			Manipulator alone, without cones <u>R122-200180-000</u>

Cohen Intra Uterine Cannula
with spring-loaded fixation, one large and one small cone

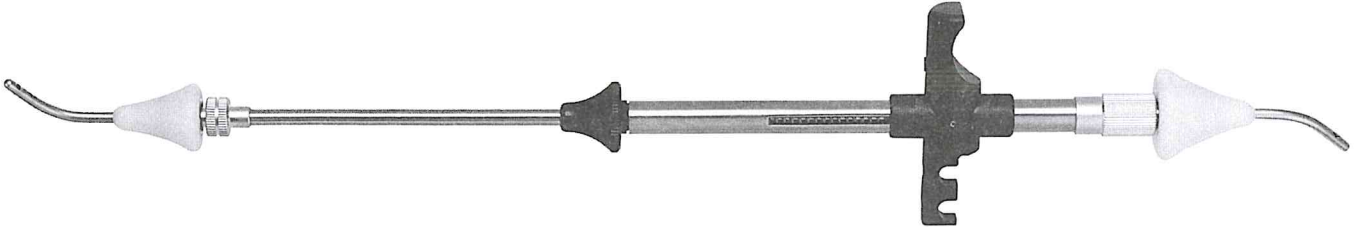

working length	Complete
170 mm	R122-250170-000

Cone alone, Ø 19 mm, small
R122-190056-000

Cone alone, Ø 25 mm, large
R122-250056-000

Uterine Cannula allone
R122-250170-001